

General Specifications

Model UT420 Digital Indicating Controller



GS 05D01C12-02E

■ General

Model UT420 Digital Indicating Controller is a simple, micro-processor based digital indicating controller with basic control capability and the user-friendly 5-digit large numerical display. The UT420 features as standard many functions which are necessary for various control applications, and all of these functions such as control function, control computation function, signal computation function, etc. can be configured by using the keys on the front panel. The instrument has an Auto-tuning, an overshoot suppressing function "SUPER" and a hunting suppressing function "SUPER2" built in as standard. Panel size is small, 48 mm (width) × 96 mm (height), and designed for saving space.

■ Main Features

- High resolution display of 5 digits. Since LEDs of 12 mm height are used for displaying measured values, the display is clearly read.
- The front panel size is 48 mm (width) × 96 mm (height) and the depth is 100 mm, designed for saving space.
- Enabling the operator to start control operation immediately after simply entering the settings.
- Parameter can be easily set using a personal computer. ("Parameter setting tool (model LL100)" sold separately is required.)
- Universal input and output enables users to set or change freely the type of measured inputs, measurement range, type of control output, etc. from the front panel.
- Contact inputs (up to 4 points) can be employed and functions assigned to each contact (The maximum number of points varies depending on the specification code.)
- Various communication function are provided. Communication is possible with personal computer, programable logic controller, and other controllers.

■ Functional Specifications

● Control Computation Functions

The following control computation functions can be selected.

Continuous PID control, Time-proportional PID control, and Relay ON/OFF control.

Target setpoint and PID parameter:

Maximum eight sets of target setpoint and PID parameter can be set.

Zone PID selection:

PID parameter set switching in up to seven measured input zones.

Auto-tuning:

Available as standard.

Preset output function:

When the instrument is in STOP mode, measured input is burnt-out, or an abnormality is found in an input circuit, a preset setpoint is output as a control output.

UT420



UT420E
"E" indicates the model with expanded functions.

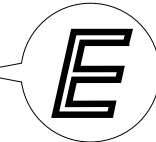

"SUPER" function:

Overshoots generated by abrupt changes in the target setpoint or by disturbances can be suppressed.

"SUPER2" function:

The function stabilizes the state of control that is unstable due to hunting, etc. without requiring any change in PID constants, when the load and/or gain varies greatly, or when there is a difference between the characteristics of temperature zones.

Control cycle time: 200 ms

Operation Mode Switching

(Note: Communication enables all the following mode switching to be executed.)

AUTO/MANUAL switching:

Bumpless switching between automatic operation mode and manual control mode is available by using the front key or contact input. The contact input has priority over front key input or switching by communication.

RUN/STOP switching:

Switching by contact input (bumpless for switching from STOP to RUN). The contact input has priority over switching by communication. In RUN mode, control computation is activated. In STOP mode, control computation ceases and a preset value is output as a control output while other functions operate normally.

REMOTE/LOCAL switching:

Switching between remote setpoint and local setpoint by instrument operation or contact input. The contact input has priority over instrument operation or switching by communication. For remote to local switching, either bumpless tracking (employing the remote setpoint on switching as the local setpoint) or without tracking (directly switching the local setpoint) can be specified.

Control Parameters Setting Range

- Proportional band: 0.1 to 999.9%
- Integral time: 1 to 6,000 s, or OFF (for Manual reset)
- Derivative time: 1 to 6,000 s, or OFF
- ON/OFF control hysteresis:
 - 0.0 to 100.0% of measured input range width
- Preset output: -5.0 to 105.0% of the output (0 mA or less cannot be output)
- Output limiter:
 - Setting range: -5.0 to 105.0% for both high and low limits
 - However, "low limit setpoint < high limit setpoint" must be satisfied.
- Shutdown function:
 - When manual control is carried out with 4 to 20 mA output, control output can be output down to about 0 mA (shutdown is specified for -5.0% or less).
- Rate-of-change limiter for output:
 - OFF or 0.1 to 100.0%/s

● Configuration of Input/Output Signal

Measured Input Computations

Input processing, Bias addition (-100.0 to 100.0%), and First order lag filter (OFF, time constant 1 to 120 s)

Remote Input Computations

(Applied to remote input only)

Input processing, Bias addition (-100.0 to 100.0%), Ratio multiplication (0.001 to 9.999), and First order lag filter (OFF, time constant 1 to 120 s)

● Alarm Functions

Alarm types:

PV high limit, PV low limit, Deviation high limit, Deviation low limit, Deenergized on deviation high limit, Deenergized on deviation low limit, Deviation high and low limits, High and low limits within deviation, Deenergized on PV high limit, Deenergized on PV low limit, SP high limit, SP low limit, Output high limit, Output low limit.

Alarm setting range:

PV/SP alarm: -100 to 100% of measured input range
 Deviation alarm: -100 to 100% of measured input range width
 Output alarm: -5.0 to 105.0% of output range
 Alarm hysteresis: 0.0 to 100.0% of measured input range width

Delay timer:

0.00 to 99.59 (minute, second)
 An alarm is output when the delay timer expires after the alarm setpoint is reached.
 Setting for each alarm is possible.

Stand-by action:

Stand-by action can be set to make PV/deviation alarm OFF during start-up or after SP change until SP reaches the normal region.

Timer function (stabilization of control status notification event) (Alarm 1 only):

This function sets the alarm 1 output to On when a preset time (timer setting) elapses after a PV has reached to the control target setpoint hysteresis band to notify that control processing has reached its stabilized status. Restarted in RUN/STOP or target value switching.

Other alarm actions:

Sensor grounding alarm:
 Detects sensor deterioration and outputs an alarm.
 Fault-diagnosis alarm:
 For input burn-out, A/D conversion error, or thermocouple reference junction compensation error.
 FAIL output:
 Abnormality in software or hardware.

Number of alarm settings: 3

The alarm status can be read via communication in addition to output as the above alarm output.

Alarm output points (see also the item "Contact output")

- Number of contact (relay) outputs: 3

Any of PV alarm, deviation alarm, SP alarm, output alarm, Fault-diagnosis alarm, sensor grounding alarm and FAIL output can be assigned to contacts for the above number of outputs. However, the timer delay alarm can be assigned to the alarm 1 output only.

● Display and Operation Functions

PV Display

PV1 is displayed on the 5-digit display. The number of display digits is 4 or 5. For thermocouple or RTD, data below the decimal point can be set not to display. The display range is -19999 to 30000 and the display span is 30000 or less. [420.00 appearing in the product photograph on page 1 cannot actually be displayed.]

Setpoint Display

A parameter name is displayed in the 3-digit display and data in the 5-digit display. There are four kind of displays of operation, operation parameter setting, setup parameter setting and select.

Operating display:

Setpoint, control output, etc. are displayed.

Operating parameters setting display:

The Operating parameters, which are mainly changed during operation, such as PID constant, are displayed.

Setup parameters setting display:

The Setup parameters to configure the functions of the instrument before starting operation are displayed.

SELECT display:

Up to five displays which are frequently accessed can be selected from the Operating parameters setting display and Setup parameters setting display to be displayed in the SELECT display.

Status Lamps

- Alarm indicating lamp:
 - Three lamps, AL1, AL2 and AL3
- Operation mode indicating lamp:
 - REM (remote operation), MAN (manual mode operation)

Operation Keys

- △, ▽ keys: Increases or decreases setpoints and other parameters displayed in the setpoint display.
- SET/ENT key: Used for setting or change set data, switching the displayed contents, and switching operation modes except for A/M.
- A/M key: Operation mode switching (Auto/Man)

Security Function

Key-lock from parameter setting and operation can be inhibited by a password.

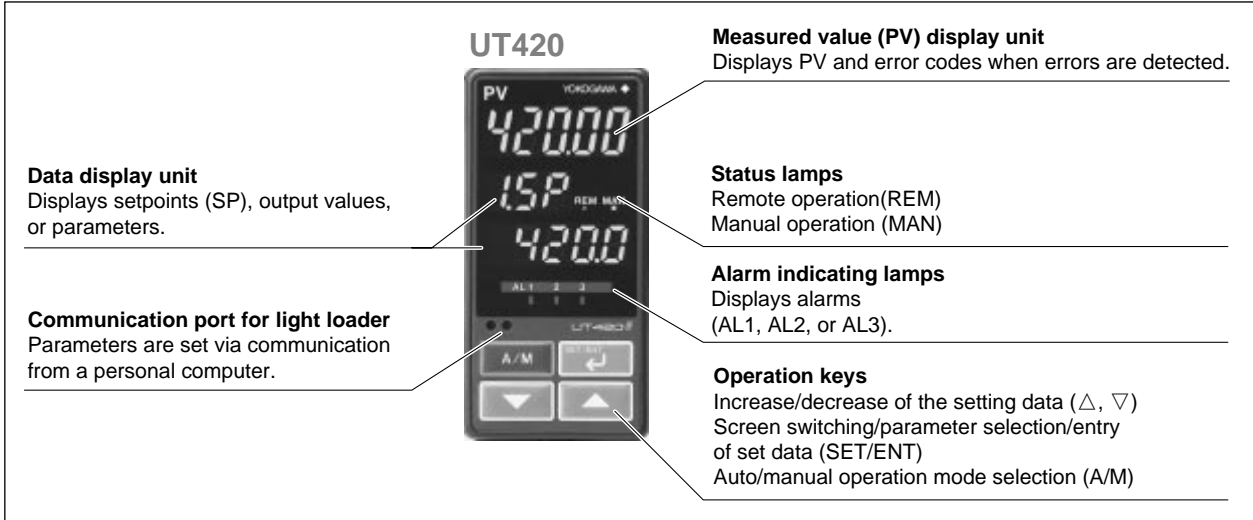

● **Communication Function**

(For optional specification code □ 7 only)

This controller has 4 types of communication protocol with one communication interface. Communication is possible with personal computer, programmable logic controller, and other controllers.

Communication Protocol

- Computer link communication:
 - Communication protocol with a personal computer
- Ladder communication:
 - Communication protocol with programmable logic controllers.
- MODBUS communication:
 - Communication protocol with a personal computer or PLC.
- Coordinated operation:
 - Protocol for coordinated operation with more than one GREEN SERIES controller. The UT420 controller can be connected as a master or slave station.

RS485 Communication Interface

The RS485 communication interface (conforms to EIA RS485) can be used for personal computer link, ladder communication, MODBUS communication or for coordinated operation.

- Maximum number of connectable controllers:
 - GREEN SERIES controller 31
- Maximum communication distance: 1200 m
- Communication method:
 - Two-wire half-duplex or four-wire half-duplex, start-stop synchronization, and non-procedural
- Communication rate:
 - 600, 1200, 2400, 4800, or 9600 bps

Examples of Communication System Configuration Diagram

(1) Personal computer link communication/MODBUS communication

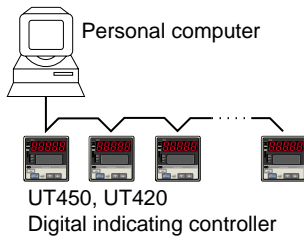

(2) Ladder communication

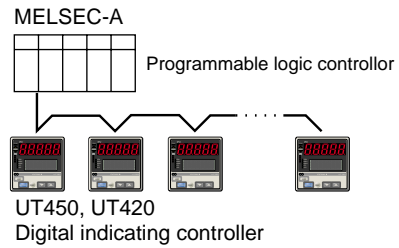

(3) Coordinated operation

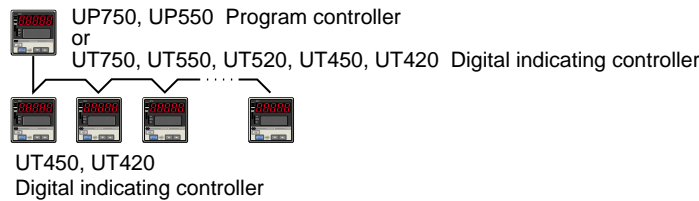

■ Hardware Specifications

● Input/Output Signal Specifications

Measured Input Signal

Number of input points: 1
 Type of input, measurement range, and measurement accuracy:
 The type of input and measurement range can be specified using the input range code shown in the table below.

Sampling period: 200 ms

Burnout detection:

Activated for thermocouple (TC) input, RTD input, or standard signal of 0.4 to 2 V or 1 to 5 V.

Possible to specify a travel of upscale, downscale, or off.

For standard signal input (see the table below), set to burn out at 0.1 V or less.

Input bias current: 0.05 μA (for TC or RTD b-terminal)

Specified current(RTD): about 0.13 mA

Input resistance:

1 MΩ or more for TC or mV input
 About 1 MΩ for DC voltage input

Allowable signal source resistance:

250 Ω or less for TC or mV input

Signal source resistance effect

0.1 μV/Ω or less

2 kΩ or less for DC voltage input

Signal source resistance effect

Approx. 0.01%/100 Ω

Allowable leadwire resistance (for RTD input):

Maximum 150 Ω/one wire (Lead resistances of three wires must be equal.)

However, it must be 10 Ω/one wire for the range of -150.0 to 150.0°C.

Effect of wiring resistance: ±0.1°C/10 Ω

Allowable input voltage:

±10 V DC for TC/mV/RTD input

±20 V DC for DC voltage input

Noise rejection ratio:

Normal mode 40 dB (50/60 Hz) or more

Common mode 120 dB (50/60 Hz) or more

Reference junction compensation error:

±1.0°C (15 to 35°C), ±1.5°C (0 to 15°C and 35 to 50°C)

Applicable standards: JIS, IEC, and DIN (ITS-90) for TC and RTD

Input type		Input range code	Instrument range (°C)	Instrument range (°F)	Instrument accuracy*1
Unspecified(when shipped from the factory)		OFF	Set the data item PV input type "IN" to the OFF option to leave the PV input type undefined.		
Thermocouple	K	1	-270.0 to 1370.0°C	-450.0 to 2500.0°F	±0.1% ±1 digit of instrument range at 0°C or more ±0.2% ±1 digit of instrument range at less than 0°C • However, ±2% ±1 digit of instrument range for type K at temperatures less than -200°C. • However, ±1% ±1 digit of instrument range for type T at temperatures less than -200°C.
		2	-270.0 to 1000.0°C	-450.0 to 2300.0°F	
		3	-200.0 to 500.0°C	-200.0 to 1000.0°F	
	J	4	-200.0 to 1200.0°C	-300.0 to 2300.0°F	
	T	5	-270.0 to 400.0°C	-450.0 to 750.0°F	
		6	0.0 to 400.0°C	-200.0 to 750.0°F	
	B	7	0.0 to 1800.0°C	32 to 3300°F	±0.15% ±1 digit of instrument range at 400°C or more ±5% ±1 digit of instrument range at less than 400°C
	S	8	0.0 to 1700.0°C	32 to 3100°F	±0.15% ±1 digit of instrument range
	R	9	0.0 to 1700.0°C	32 to 3100°F	
	N	10	-200.0 to 1300.0°C	-300.0 to 2400.0°F	±0.1% ±1 digit of instrument range ±0.25% ±1 digit of instrument range for temperature at less than 0°C
	E	11	-270.0 to 1000.0°C	-450.0 to 1800.0°F	±0.1% ±1 digit of instrument range at 0°C or more ±0.2% ±1 digit of instrument range at less than 0°C • However, ±1.5% ±1 digit of instrument range for type E at temperature less than -200°C.
	L (DIN)	12	-200.0 to 900.0°C	-300.0 to 1600.0°F	
	U (DIN)	13	-200.0 to 400.0°C	-300.0 to 750.0°F	
		14	0.0 to 400.0°C	-200.0 to 1000.0°F	
	W (DIN)	15	0.0 to 2300.0°C	32 to 4200°F	±0.2% ±1 digit of instrument range
	Platinel 2	16	0.0 to 1390.0°C	32.0 to 2500.0°F	±0.1% ±1 digit of instrument range
	PR20-40	17	0.0 to 1900.0°C	32 to 3400°F	±0.5% ±1 digit of instrument range at 800°C or more Accuracy not guaranteed for temperature less than 800°C
	W97Re3-W75Re25		0.0 to 2000.0°C	32 to 3600°F	±0.2% ±1 digit of instrument range
RTD	JPt100	30	-200.0 to 500.0°C	-300.0 to 1000.0°F	±0.1% ±1 digit of instrument range (Note1) (Note2)
		31	-150.00 to 150.00°C	-200.0 to 300.0°F	±0.2% ±1 digit of instrument range (Note1)
	Pt100	35	-200.0 to 850.0°C	-300.0 to 1560.0°F	±0.1% ±1 digit of instrument range (Note1) (Note2)
		36	-200.0 to 500.0°C	-300.0 to 1000.0°F	
		37	-150.00 to 150.00°C	-200.0 to 300.0°F	±0.2% ±1 digit of instrument range (Note1)
Standard signal	0.4 to 2V	40	0.400 to 2.000 V	Display range -19999 to 30000 Display span 30000 or less (Decimal point position changeable)	±0.1% ±1 digit of instrument range
	1 to 5V	41	1.000 to 5.000 V		
DC voltage	0 to 2V	50	0.000 to 2.000 V		
	0 to 10V	51	0.00 to 10.00 V		
	-10 to 20mV	55	-10.00 to 20.00 mV		
	0 to 100mV	56	0.0 to 100.0 mV		

Note1: The accuracy is ±0.3°C of instrument range ±1 digit for a temperature range from 0 to 100°C

Note2: The accuracy is ±0.5°C of instrument range ±1 digit for a temperature range from -100 to 200°C.

*1: Performance in the standard operating conditions (at 23±2°C, 55±10% RH, and 50/60Hz power frequency)

Remote Input Signal

(UT420-□7 or -□8 only)

Functions: Remote input (analog input) for setting SP
 Input type: Settable within the range of voltage input
 1 to 5 V DC, 0 to 2 V DC, 0 to 10 V DC or 0.4 to 2.0 V DC.

Number of inputs: 1 point
 Sampling period: 200 ms
 Input resistance: Approx. 1 MΩ
 Input accuracy: ±0.3% ± 1 digit of F.S. for 0 to 2 V DC input
 ±0.2% ± 1 digit of F.S. for 0 to 10 V DC input
 ±0.375% ± 1 digit of F.S. for 0.4 to 2.0 V DC range
 ±0.3% ± 1 digit of F.S. for 1 to 5 V DC range
 Performance in the standard operating conditions (at 23±2°C, 55±10% RH, and 50/60Hz power frequency)

15 V DC Sensor Power Supply

Supplies power to the 2-wire transmitter. The current signal is converted to a voltage signal by placing a resistor (arbitrary from 10 to 250 Ω) and is read by the measured input block. Cannot be used simultaneously with the retransmission output.

Supply voltage 14.5 to 18.0 V DC, maximum supply current about 21 mA (with the protection circuit at field short-circuit)

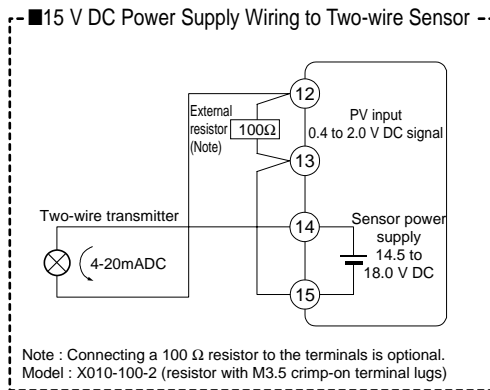

Retransmission Output

Any of the PV, target setpoint or control output is output. Cannot be used simultaneously with the 15 V DC sensor power supply.

Number of output points: 1
 Output signal: 4 to 20 mA DC
 Load resistance: 600 Ω or less
 Output accuracy: ±0.1% of span
 Performance in the standard operating conditions (at 23±2°C, 55±10% RH, and 50/60Hz power frequency)

Control Outputs

Select the control output from the following output types depending on the product model.

Current output
 Number of output points: 1 (switchable to voltage pulse output)
 Output signal: 4 to 20 mA DC
 Load resistance: 600 Ω or less
 Output accuracy: ±0.1% of span
 Performance in the standard operating conditions (at 23±2°C, 55±10% RH, and 50/60Hz power frequency)

Voltage pulse output

Number of output points: 1 (switchable to current output)
 Output signal: ON voltage 12 V DC or more (load resistance 600 Ω or more; current on short-circuiting about 30 mA)
 OFF voltage 0.1 V DC or less
 Resolution: 10 ms or 0.1% of output value, whichever is greater.

Relay contact output

Number of output points: 1
 Output signal: At three terminals of NC, NO, and Common
 Contact rating: 250 V AC, 3 A or 30 V DC, 3 A (resistive load)
 Resolution: 10 ms or 0.1% of output value, whichever is greater.

Contact Inputs

Usage: Target setpoint switching, REMOTE/LOCAL switching, RUN/STOP switching
 Number of input points: Varies with optional codes (as shown below):

Model and Suffix Code	Number of Input Points
UT420- 00	2
UT420- 07	4
UT420- 08	4

Input type: Non-voltage contact input or transistor open collector input
 Input contact rating: 12 V DC, 10 mA or more
 On/off detection:
 For non-voltage contact input,
 On .. contact resistance 1 kΩ or less;
 Off .. contact resistance 20 kΩ or more
 For transistor contact input,
 On .. 2 V or less;
 Off .. leak current 100 μA or less
 Minimum retention time for status detection: 0.6 s

Contact Outputs

Usage: Alarm output, FAIL output
 Number of output points: 3 (relay output)
 Relay contact rating: 240 V AC, 1 A or 30 V DC, 1 A

● Display Specifications

Measured value (PV) display:
 5-digit seven-segment red color LED display;
 height of letters 12 mm
 Data display:
 3 digits + 5 digits, seven-segment red color LED display; height of letters 9.3 mm
 Status indicating lamps: LEDs

● Conformance to Safety and EMC Standards

Safety: Compliant with IEC/EN61010-1: 2001, approved by CSA1010, approved by UL508.
 Installation category : CAT. II (IEC/EN61010, CSA1010) Pollution degree : 2 (IEC/EN61010, CSA1010)
 Measurement category : I (CAT. I : IEC/EN61010)
 Rated measurement input voltage : 10V DC max.(across terminals), 300V AC max.(across ground)

Rated transient overvoltage : 1500V (Note)

Note : It is a value on the safety standard which is assumed by IEC/EN61010-1 in measurement category I, and is not the value which guarantees an apparatus performance.

EMC standards:Complies with EN61326

During test, the controller continues to operate with the measurement accuracy within $\pm 20\%$ of the range.

● Construction, Installation, and Wiring

Construction: Dust-proof and Drip-proof front panel conforming to IP55.

For side-by-side close installation, controller loses its dust-proof and drip-proof protections.

Material of the body: ABS resin and polycarbonate

Case color: Black

Weight: Approx. 1 kg or less

External dimensions:

48W × 96H × 100D (from the panel face)
(mm)

Mounting: Direct panel mounting; mounting bracket, one each for upper and lower mounting

Panel cutout dimensions:

$45^{+0.6}_0$ W × $92^{+0.8}_0$ H (mm)

Mounting attitude:

Up to 30 degrees from horizontal; Must not face downward.

Wiring connection:

With M3.5 screw terminals (for signal, power and grounding wiring)

● Power Supply and Isolation

Power supply: Rated voltage 100 to 240 V AC ($\pm 10\%$), 50/60 Hz

Power consumption: MAX. 20 VA or less (MAX. 8.0W)

Memory backup: EEPROM. Service life approx. 100,000 times of writings

Withstanding voltage:

1500 V AC for 1 min.
between primary terminals and secondary terminals

1500 V AC for 1 min.
between primary terminals and ground terminal

1500 V AC for 1 min.
between ground terminal and secondary terminals

500 V AC for 1 min.
between secondary terminals

(where primary terminals stand for power and relay output terminals and secondary terminals, analog input and output signal terminals, voltage pulse output terminals, and contact input terminals.)

Isolation resistance:

20 M Ω or more for 500 V DC applied
between power terminals and ground terminal

Grounding: Class D grounding (grounding resistance of 100 Ω or less)

Isolation Specifications

Measured input terminal: Isolated from other input/output terminals, but not isolated from internal circuits.

Remote input terminal: Isolated from other input/output terminals and internal circuits.

Terminals for control output (current or voltage pulse) and retransmission: Not isolated between control outputs and retransmission output, but isolated from other input/output terminals and internal circuits.

Relay contact control output terminals: Isolated from other contact output terminals, other input/output terminals and internal circuits.

Contact input terminals: Not isolated from other contact input terminals mutually and communication terminals, but isolated from other input/output terminals and internal circuits.

Relay contact alarm output terminals: Isolated from other input/output terminals and internal circuits.

Transistor contact alarm output terminals: Not isolated from other contact alarm outputs terminal mutually, but isolated from other input/output terminals and internal circuits.

RS-485 communication terminals: Not isolated from contact input terminals, but isolated from other input/output terminals and internal circuits.

Power terminals: Isolated from other input/output terminals and internal circuits.

Ground terminal: Isolated from other input/output terminals and internal circuits.

● Environmental Conditions

Normal operating conditions:

Ambient temperature: 0 to 50°C (40°C or less in close mounting side-by-side)

However, 0 to 45°C (35°C or less in close mounting side-by-side) if two analog current output points and the control relay output are used simultaneously.

Temperature change rate limit:10°C/h or less

Ambient humidity: 20 to 90% RH (no condensation)

Magnetic field: 400 A/m or less

Continuous vibration (5 to 14 Hz):

Peak-to-peak amplitude 1.2 mm or less

Continuous vibration (14 to 150 Hz):

4.9 m/s² or less

Short period vibration: 14.7 m/s², 15 s or less

Shock: 147 m/s² or less, 11 ms

Installation altitude: 2000 m or less above sea level

Warm-up time: 30minutes or more

Transportation and storage conditions:

Temperature: -25 to 70°C

Temperature change rate limit:20°C/h or less

Humidity: 5 to 95% RH (no condensation)

Effects of operating conditions

Effect of ambient temperature:

Whichever is greater, $\pm 1 \mu\text{V}/^\circ\text{C}$ or $\pm 0.01\%$ of F.S./ $^\circ\text{C}$ for voltage or thermocouple inputs.

$\pm 0.02\%$ of F.S./ $^\circ\text{C}$ for remote input

$\pm 0.05^\circ\text{C}/^\circ\text{C}$ (ambient temperature) or less for RTD inputs.

$\pm 0.05\%$ of F.S./ $^\circ\text{C}$ or less for analog outputs.

Effect of power supply fluctuation (within rated voltage range):

Whichever is greater, $\pm 1 \mu\text{V}/10 \text{ V}$ or

$\pm 0.01\%$ of F.S./10 V for remote inputs.

$\pm 0.05\%$ of F.S./10 V or less for analog outputs.

Function Block Diagram for Standard Type

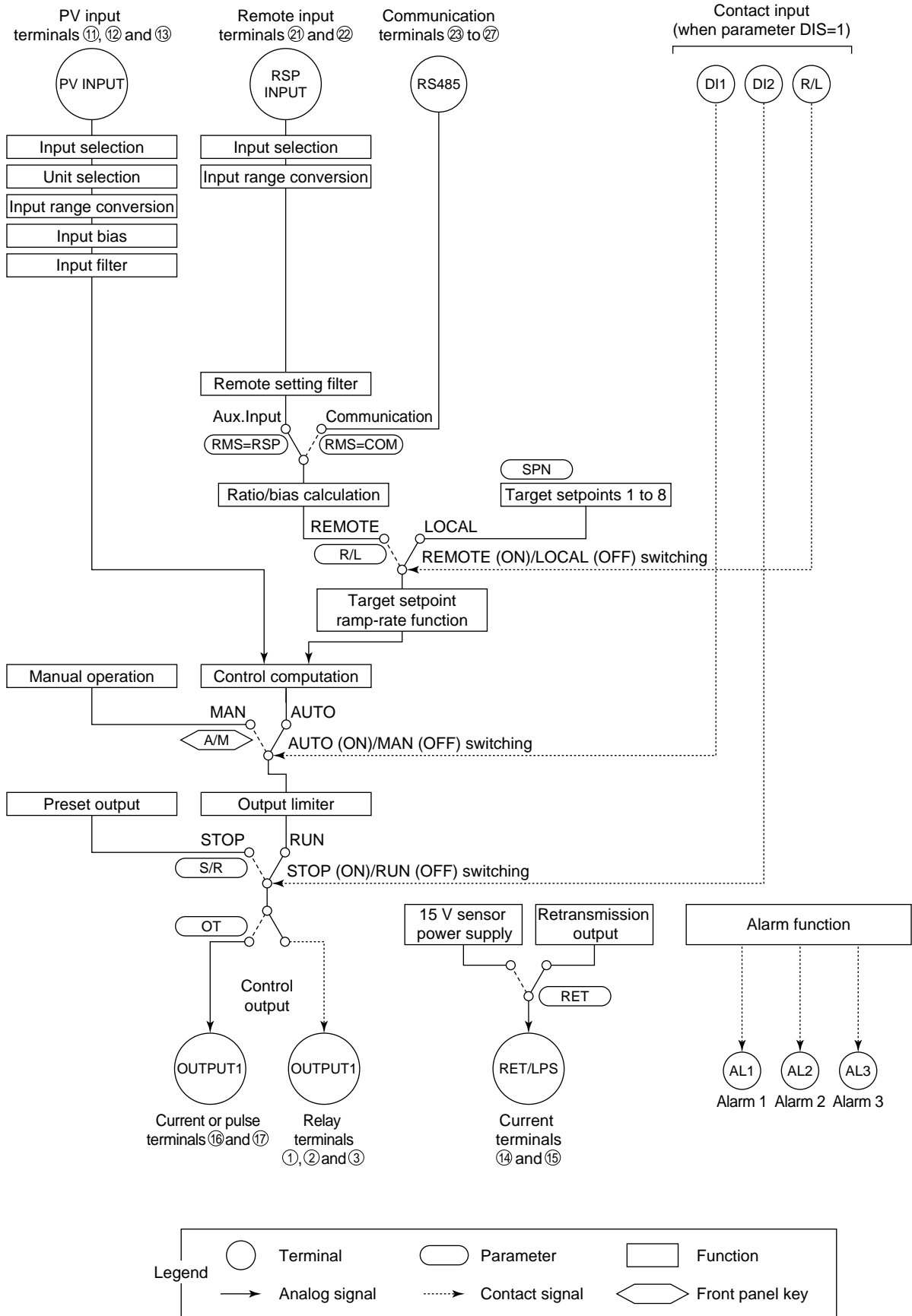

UT420 Standard Type (Model UT420-0□), Terminal Arrangements

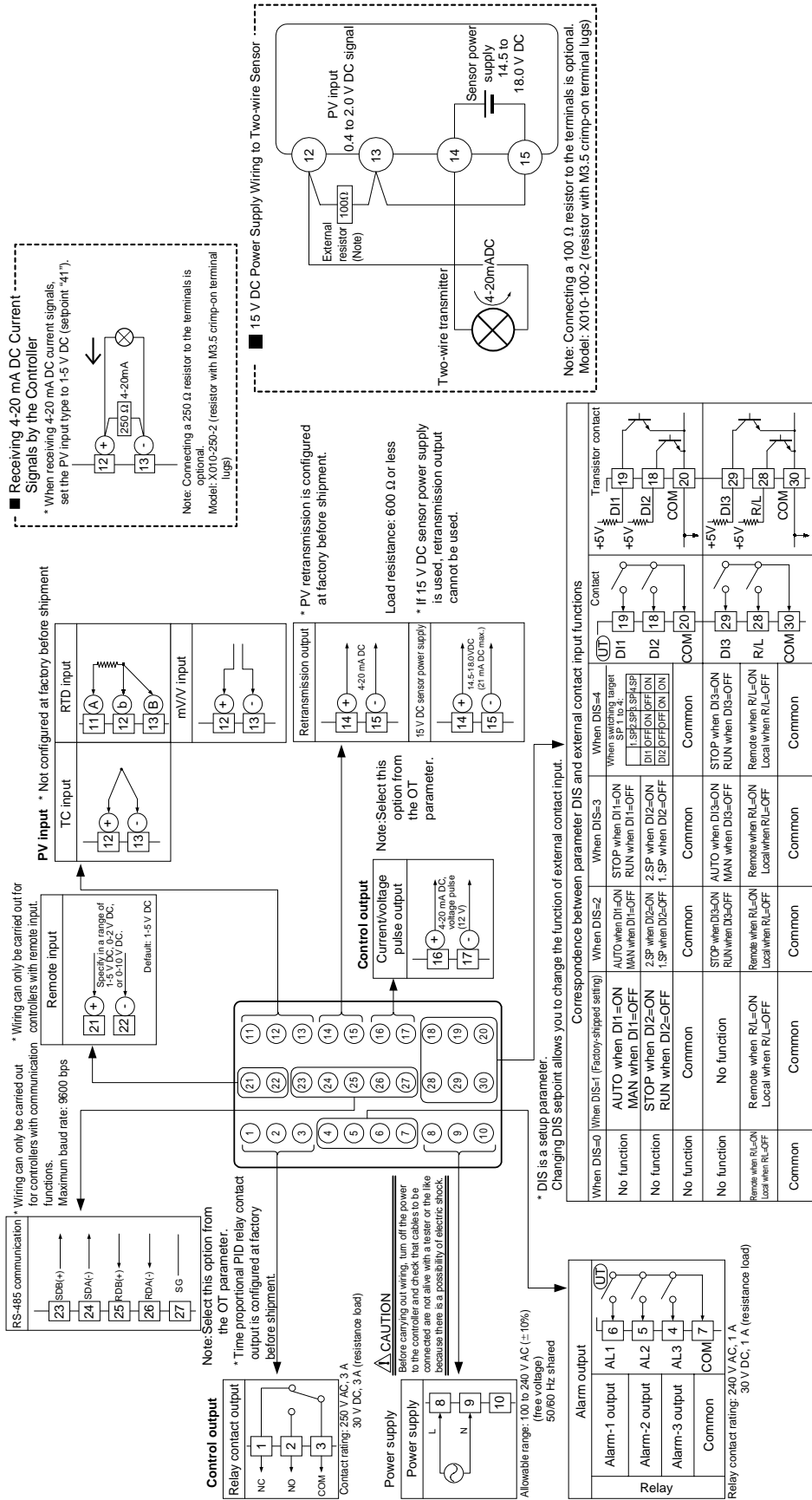

External Dimensions and Panel Cutout Dimensions

Unit: mm

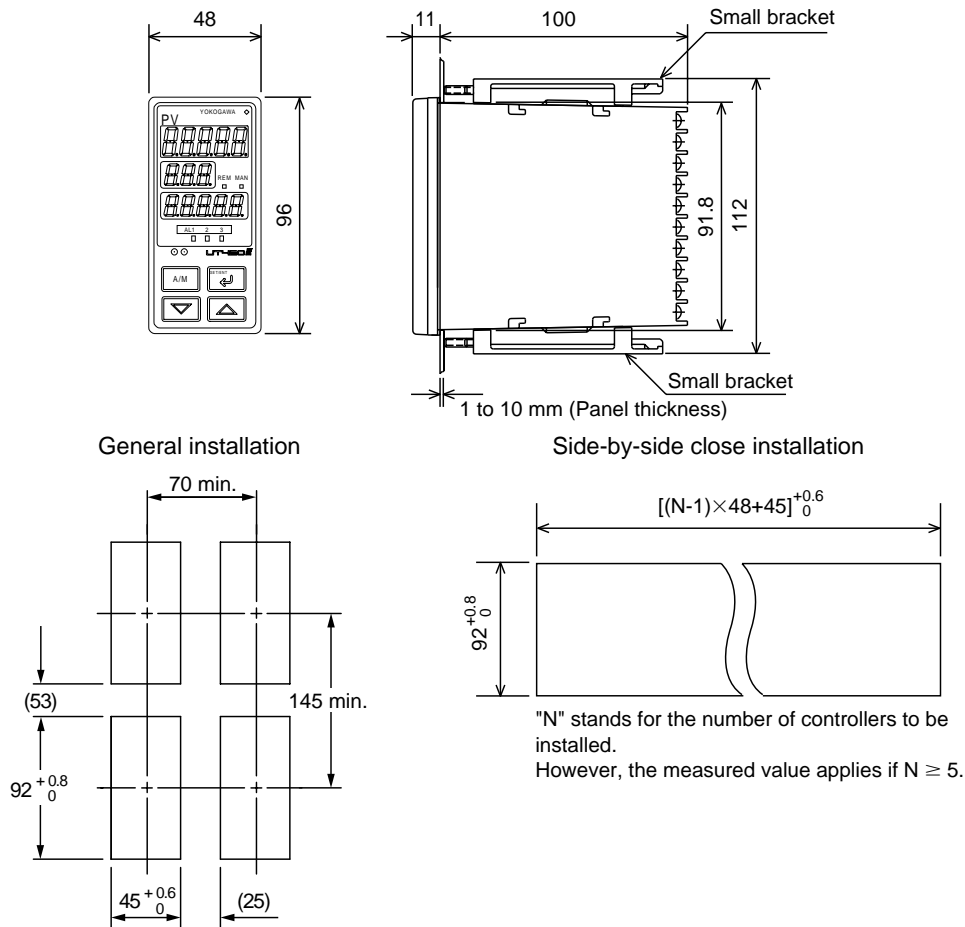

Model and Suffix Codes

Model	Suffix Code	Description
UT420		Digital indicating controller (provided with retransmission output and 15 V DC loop power supply as standard)
Type	-0	Standard type
Optional functions	0	None
	7	With communication, remote input, and 2 additional DIs
	8	With remote input and 2 additional DIs

Standard accessories: Brackets (mounting hardware), unit label, User's Manuals, and User's Manual Reference (CD-ROM version).

Items to Be Specified When Ordering

Model and suffix codes, necessary/unnecessary of User's Manual or QIC.